

HV DC Contactor

SEV250AD HV DC Contactor



USES

The utility model has the advantages that the utility model is provided with one normally open contact, which is suitable for charging piles, electric four wheeled vehicles, new energy vehicles, energy saving and environmental protection systems, road traffic lighting systems, programmable power supply and uninterruptible power supply equipment.

SEV	250	A	D	X	L	-□	※	/12V
1	2	3	4	5	6	7	8	9
1	Product type							
2	Rated current							
3	Circuit structure: A - normally open; B - normally closed; F - normally open with one auxiliary switch (the auxiliary switch and main contact have the same structure); G - one normally closed with one auxiliary (auxiliary switch and main contact have the same structure). (For other auxiliary switch structures, add 2 or 3 numbers after the model to describe the auxiliary switch structure)							
4	Coil type: D single coil; H with coil economizer; K Two joint magnetic retention(Single coil, Two joint self-locking); 2K Three joint magnetic retention(Double coil, Three joint self-locking); P Signal control							
5	Coil outgoing mode: X Wire (390mm); P Spade terminals (4.8); W thread(M4); O Other							
6	Mounting bracket type: L Vertical(default)							
7	None: auxiliary switch and main contact have the same structure (default); 2: The structure of auxiliary switch and main contact is opposite; 3: Special auxiliary switch structure							
8	Other special functions: V with capacitive type load; N no polarity							
9	Coil rated voltage: DC6V,12V,24V,36V,48V,60V,72V,84V,120V,150V,DC220V,AC220V etc.							

USE OF THE ENVIRONMENT

Contact lead M8 tightening	≥9.0 appropriate
Coil lead mode	Wire dipping tin
Ambient temperature	-40~+85℃
Relative humidity	+20℃ 98%
Vibration freq. at the fixed	3G, 1~50Hz amplitude 0.5mm
Concussion	(60~100) time/minute、
Altitude	2000m
Installation direction	Random
International Protection	IP68

ORDER INSTRUCTION

U.N.W.	602g
Package QTY.	40PCS
Mounting bracket type	L Vertical(default)

## TECHNICAL PARAMETERS

(Version 3.03)

SAYOON Product Type	SEV250AD
Contact form	1 NO(SPST-NO) or 1NC(SPST-NC)
Coil Rated voltage (DC V)	DC6V,12V,24V,36V,48V,60V,72V,84V,120V,150V,DC220V,A
Contact voltage (DC V)	5-1000V
Contact circuit rated load current (DC-1)	250A
Typical voltage drop across contacts per 100A	≧80mV
The cooling pull-in voltage at (20±5)°C (V)	≧70%
The cooling drop-out voltage at (20±5)°C (V)	≧35%, ≦5%
Working voltage range of 40°C coil	0.8-1.2Us
Drop-out time (n/o contacts to open)	30ms
Pull-in time (n/o contacts to close)	5ms
Maximum bounce time for contact connection	10ms
Maximum bounce time for contact disconnection	7ms
Insulation Resistance	100MΩ
Electric strength to resist	50Hz/60Hz 2200VAC 1minute
Typical fault currents which can be ruptured	1000A/5ms at 48V DC
Coil power (W)	8-20
Temperature rise of coil (K)	≦55
Temperature rise on outgoing terminal (K)	≦65
Electrical life	20,000 times
Mechanical life	300,000 times
Work specification	Continuous
Contact material	Alloy
Inrush time (max)	130ms
Maximum switching current	2000A 320VDC (more than once)
Maximum switching power	640kW
Load terminal type	M8 Screw

## LOAD CHARACTERISTIC CURVE

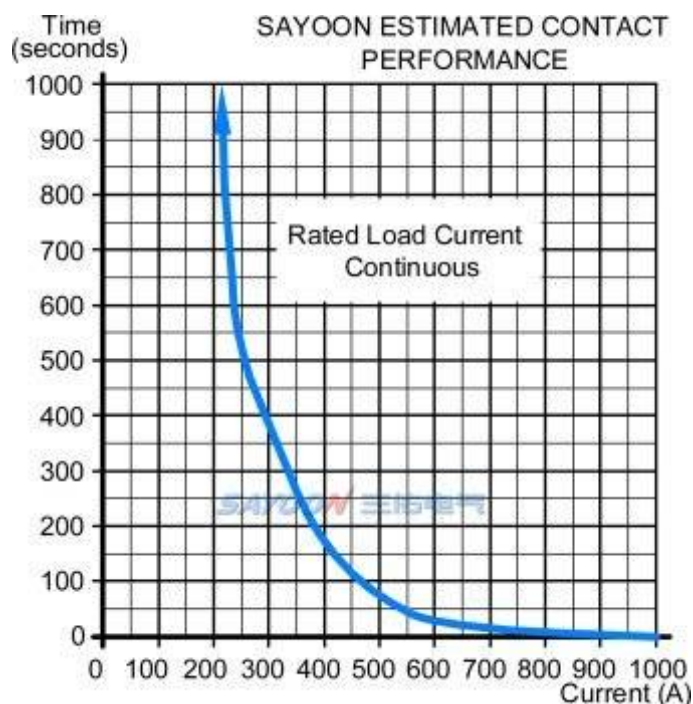
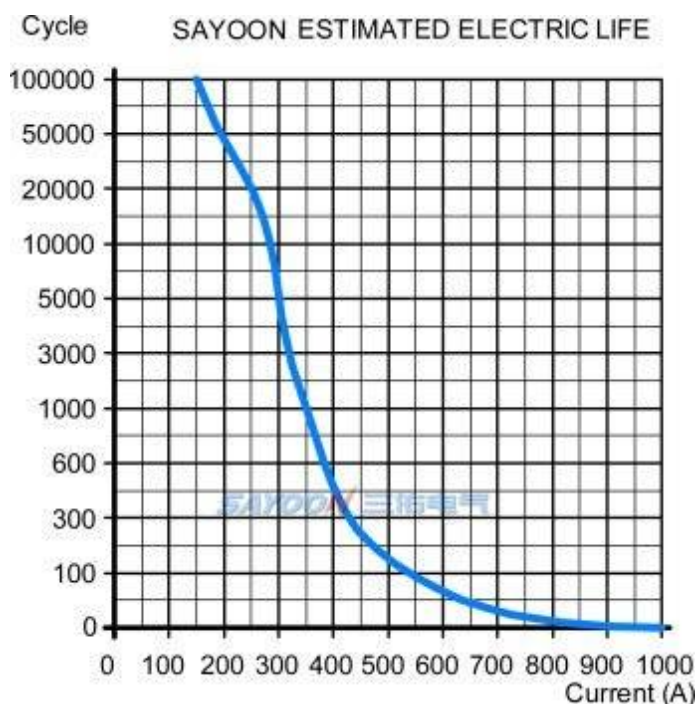

## OTHER TECHNICAL PARAMETERS

Coil terminal type	0.3 square silicone wire, 390mm long
Auxiliary contact rated load (optional)	3A/30VDC
Testing organization certification	CCC,CE,FCC,RoHS

Note:As regarding to the different using environments of customers which requires different focus of the functions,and in order to improve the comprehensive properties of our products,sayoon may adjust the coil parameters,temperature rise and so on. The above parameters are for reference only, For details, please refer to the guidelines for selection and use of the SAYOON DC contactor.

## INSTALLATION DIAGRAM

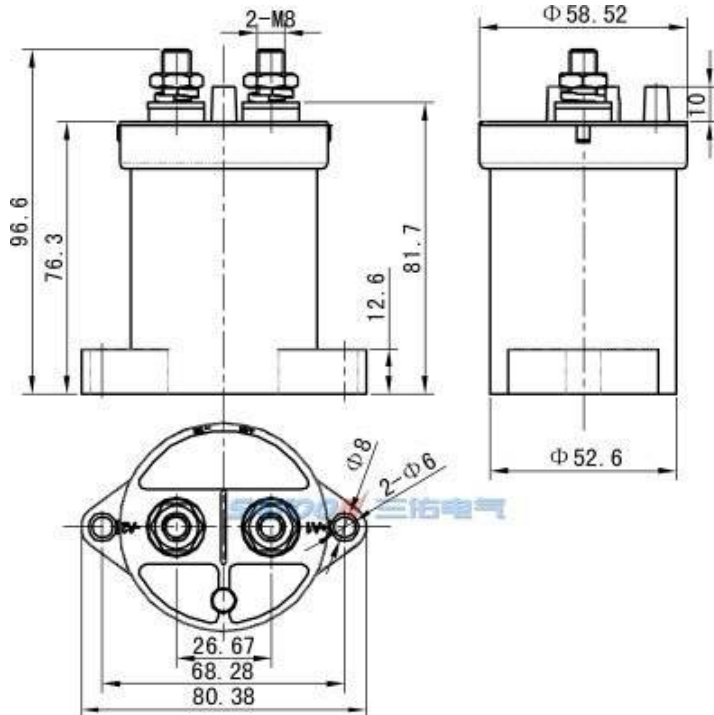

## WIRING DIAGRAM

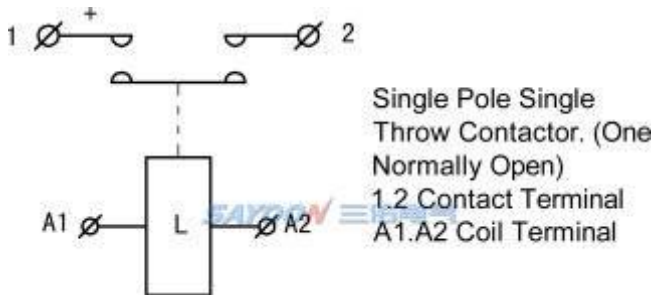

## TEMPERATURE RISE CURVE

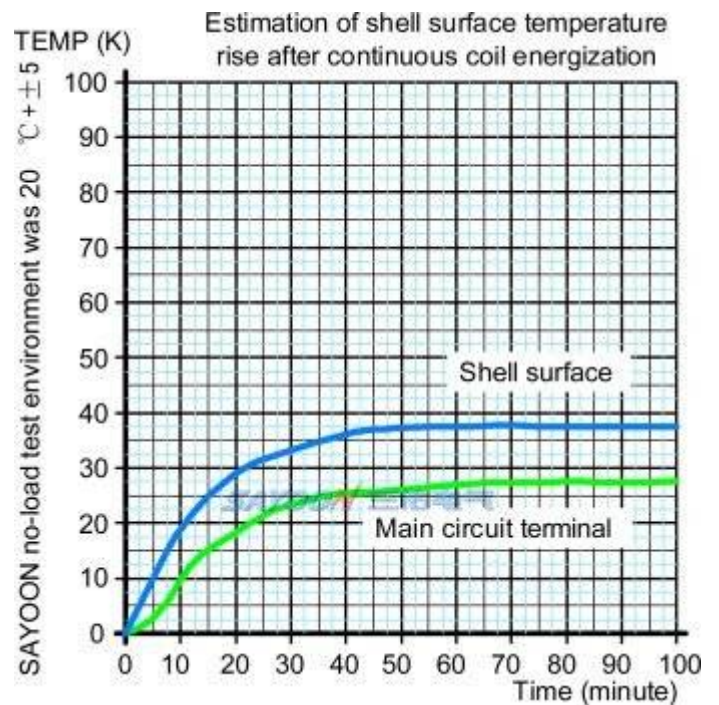

## FEATURES

Suitable for new energy electric vehicles, charging facilities, photovoltaic, wind power generation systems, automotive air conditioning, communication power, UPS, power and other electrical control circuit of the switch control, with small size, large load capacity, no spark, long service life, maintenance simple and other characteristics, by users. 1 DC high voltage power: the product cavity filled with rare mixed gas, arc cooling capacity, 2 control load capacity: with 30A-1000A, working voltage range of 5-1000VDC load capacity; 3 safety: insulation structure, can be in flammable or hazardous environment work, coil and contacts will not oxidation and pollution; 4, compared with similar products small size, light weight, power consumption. The product in accordance with the standard JB2286-78, JB3974-85, YD / 585-92, YD / T512-92 requirements; after the factory and relevant test unit test, meet the requirements of the standard specification, users use for many years, maximum to meet user needs, quality and reliable.

## ORDER FORM DESCRIPTION

When ordering, please state the following: name, full model, control coil voltage specification, installation frame type, whether with auxiliary contact, order quantity. For example: HV DC Contactor SEV200AD-□-□/24V 100pcs, indicating the load rated current 200A, without auxiliary contact, default mounting bracket, coil control voltage 24V purchase 100pcs. Special voltage specification products, such as user needs can be special order.